

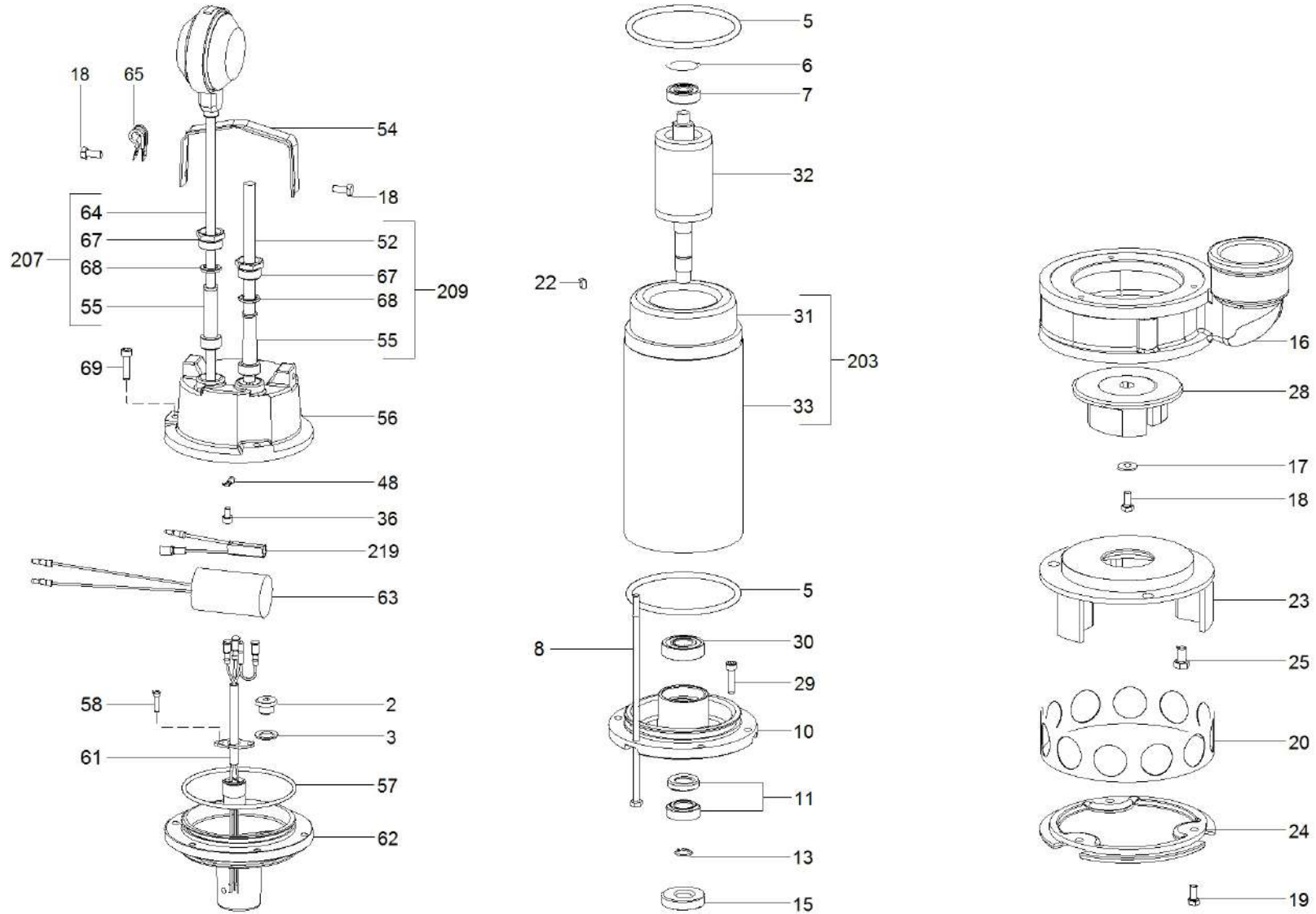





































Semisom 635 VA - HA





















Semisom 635 VA - HA

	Code	N.	Description	UM	Qty
	05315020	2	COPPER TAP 14X1,5 CIL	N	1
	05603005	3	PACKING FASIT 205 14X21H2	N	1
	05905100	5	O RINGS Di97,8X5,34 RUBBER	N	2
	05905105	5	O RINGS Di97,8X5,34 VITON	N	2
	05805005	6	FLAT SPRING De31,7 SP0,5 STEEL	N	1
	01801005	7	BALL BEARING 6201 12X32X10	N	1
	06810015	8	TIE-ROD SEMISOM CH10 H243	N	3
	05110030	10	FLANGE BBC199 SEMISOM	N	1
	03002030	11	COMPL MECH. SEAL 16 VITON SEM	N	1
	03002036	11	MECH. SEAL SEMISOM SIL/ALOX	N	1
	02201100	13	CIRCLIP UNI3653 A16 A4	N	1
	06701035	15	PACKING RING NBR 16X40X10	N	1
	06701045	15	PACKING RING 16X40X10 VITON	N	1
	02805020	16	VOLUTE BBC160 SEMISOM 635 VERT	N	1
	02805021	16	VOLUTE BBC3510 SEMISOM 635 HOR	N	1
	03808020	17	WASHER 18 X 6 H3 A2 DIN 9021	N	1
	02225040	18	SCREW TE UNI5739 M6X14 A2	N	3
	02225040	19	SCREW TE UNI5739 M6X14 A2	N	3

Semisom 635 VA - HA

	Code	N.	Description	UM	Qty
	05001060	20	FILTER FOR SEMISOM 262-435-635	N	1
	02204010	22	KEY UNI6604/A 5X5X10 S. STEEL	N	1
	03705005	23	FOOT BBC161 SEMISOM 635	N	1
	05110005	24	FLANGE BBC171 SEM. 465->	N	1
	02225050	25	SCREW TE UNI5739 M8X14 A2	N	3
	03505070	28	IMPELLER BBC352 SEM. 635	N	1
	02221060	29	SCREW TCEI UNI5931 M6X20 A2	N	3
	01801010	30	BALL BEARING 6203 17X40X12	N	1
	02720015	31	W.STAT.SEM. H100 1PH V230 55	N	1
	01105015	32	MOT.SHAFT SEMIS H100 1-3PH 55	N	1
	01420015	33	CYLINDER SEMISOM 635 H230 55	N	1
	02221010	36	SCREW TCEI UNI5931 M5X10 A2	N	1
	02230101	48	EYELET THIMBLE 1,5 5	N	2
	02230050	51	HEAD CONNECTOR 1,5 MM	N	3
	04305025	54	HANDLE SEMISOM C/I	N	1
	04805085	55	C. CLAMPING TAP 9,5X20H60	N	2
	02305075	56	COVER BBC406 SEMISOM INT.CAP	N	1
	05905156	57	O RINGS Di101,2X3,53 RUBBER	N	1

Semisom 635 VA - HA

	Code	N.	Description	UM	Qty
	02221005	58	SCREW TCEI UNI5931 M4X16 8.8	N	2
	01730010	61	KIT SEM. INT. CAPAC.+ FLOAT	N	1
	03905066	62	UPPER SUPPORT SEM.C/I BBC387	N	1
	01735020	63	CAPACITOR KIT 20MF	N	1
	02231045	65	STAPLE IN AISI-304 FOR SEMISOM	N	1
	02207040	67	CABLE CLAMPING NUT SEMISOM /3	N	2
	02211105	68	C.CLAMP WASHER NYLON 13,5X20H2	N	2
	02221065	69	SCREW TCEI UNI5931 M6X25 A2	N	3
	01510005	203	CYL+STAT SEMISOM H100 230V 55	N	1
	01715009	207	FL.SWTCH KIT 0,6M NEO.AD8SEM/3	N	1
	01710210	209	KIT R.CAB.3X1 H07AD8 SEM. 5MT	N	1
	01725052	209	KIT R.CAB.H07AD8 SEM/2 10MT+PL	N	1
	57401020	210	OIL ACER 15	KG	1
	05305030	211	PLASTIC TAP NEUT 2"	N	1
	02241005	212	VARIOUS ADHESIVE LABELS	N	3
	99802050	213	PAINT SEMISOM - DOMOSOM	N	1
	01745015	219	AMP. THERM. KIT 7,5A - BLUE	N	1